

1-480349-0 ✓ ACTIVE

MATE-N-LOK | Commercial MATE-N-LOK

TE Internal #: 1-480349-0

Rectangular Power Connectors, Housing, Plug, Wire-to-Wire, 1 Position, Wire & Cable, UL 94V-2, Standard Part - Not Glow Wire, Commercial MATE-N-LOK

[View on TE.com >](#)



Connectors > Power Connectors > Rectangular Power > Rectangular Power Connectors

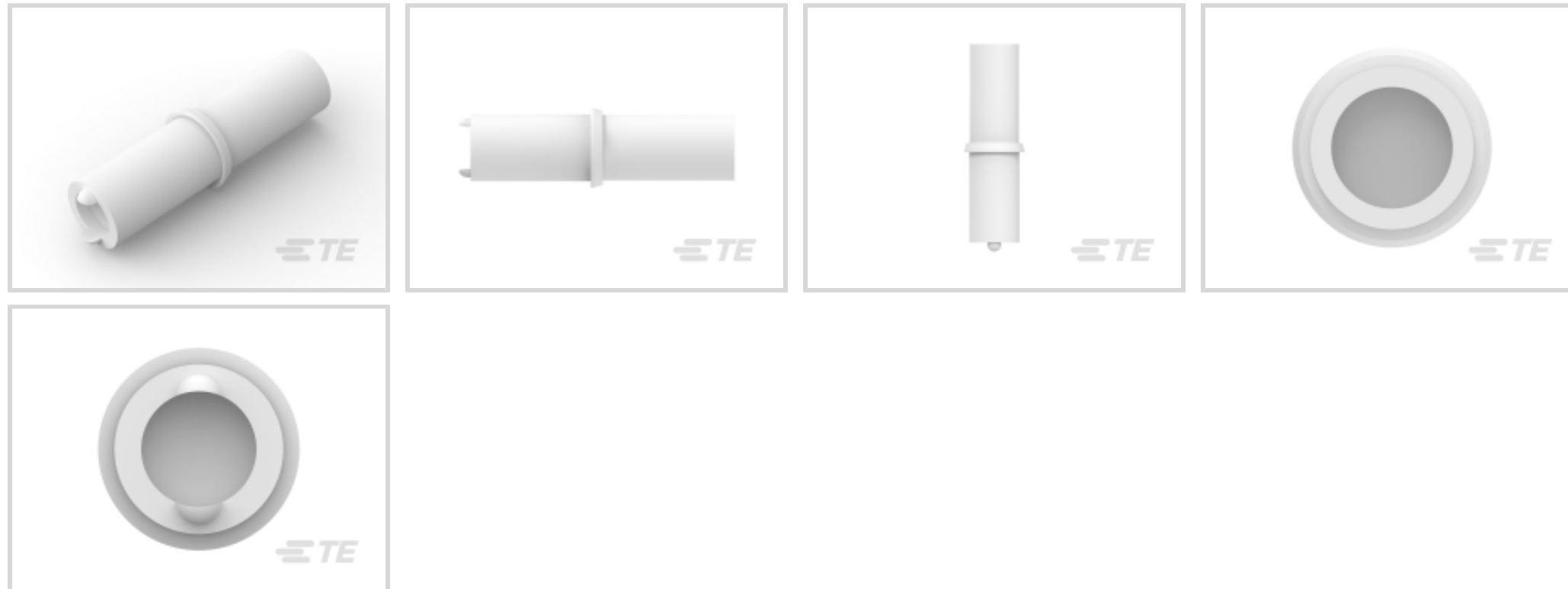

Rectangular Power Connector Type: **Housing**

Connector & Housing Type: **Plug**

Connector System: **Wire-to-Wire**

Number of Positions: **1**

Sealable: **No**

Features

Product Type Features

Rectangular Power Connector Type	Housing
Connector & Housing Type	Plug
Connector System	Wire-to-Wire
Sealable	No
Connector & Contact Terminates To	Wire & Cable

Configuration Features

Number of Positions	1
---------------------	---

Electrical Characteristics

Operating Voltage	250 VAC
-------------------	---------

Contact Features

Contact Retention Within Housing	Without
Contact Type	Socket

Termination Features

--	--



Termination Method to Wire & Cable	Crimp
------------------------------------	-------

Mechanical Attachment

Panel Mount Feature	Without
---------------------	---------

Connector Mounting Type	Cable Mount (Free-Hanging)
-------------------------	----------------------------

Housing Features

Housing Color	Natural
---------------	---------

Housing Material	Nylon
------------------	-------

Usage Conditions

Operating Temperature Range	-55 – 105 °C[-67 – 221 °F]
-----------------------------	----------------------------

Operation/Application

Circuit Application	Power & Signal
---------------------	----------------

Identification Marking

Circuit Identification Feature	Without
--------------------------------	---------

Industry Standards

UL Flammability Rating	UL 94V-2
------------------------	----------

Glow Wire Rating	Standard Part - Not Glow Wire
------------------	-------------------------------

UL Rating	Certified, Recognized
-----------	-----------------------

Agency/Standard Number	E28476
------------------------	--------

CSA File Number	LR16455
-----------------	---------

VDE Tested	No
------------	----

Agency/Standard	CSA, UL
-----------------	---------

Packaging Features

Packaging Method	Package
------------------	---------

Packaging Quantity	1
--------------------	---

Other

For Use With	Pin (Cap) Housing
--------------	-------------------

Product Compliance

[For compliance documentation, visit the product page on TE.com>](#)

EU RoHS Directive 2011/65/EU	Compliant
------------------------------	-----------

EU ELV Directive 2000/53/EC	Compliant
-----------------------------	-----------

China RoHS 2 Directive MIIT Order No 32, 2016	No Restricted Materials Above Threshold
---	---



EU REACH Regulation (EC) No. 1907/2006

Current ECHA Candidate List: JUNE 2022 (224)

Candidate List Declared Against: JUNE 2022 (224)

Does not contain REACH SVHC

Halogen Content

Low Halogen - Br, Cl, F, I < 900 ppm per homogenous material. Also BFR/CFR/PVC Free

Solder Process Capability

Not applicable for solder process capability

Product Compliance Disclaimer

This information is provided based on reasonable inquiry of our suppliers and represents our current actual knowledge based on the information they provided. This information is subject to change. The part numbers that TE has identified as EU RoHS compliant have a maximum concentration of 0.1% by weight in homogenous materials for lead, hexavalent chromium, mercury, PBB, PBDE, DBP, BBP, DEHP, DIBP, and 0.01% for cadmium, or qualify for an exemption to these limits as defined in the Annexes of Directive 2011/65/EU (RoHS2). Finished electrical and electronic equipment products will be CE marked as required by Directive 2011/65/EU. Components may not be CE marked. Additionally, the part numbers that TE has identified as EU ELV compliant have a maximum concentration of 0.1% by weight in homogenous materials for lead, hexavalent chromium, and mercury, and 0.01% for cadmium, or qualify for an exemption to these limits as defined in the Annexes of Directive 2000/53/EC (ELV). Regarding the REACH Regulation, the information TE provides on SVHC in articles for this part number is based on the latest European Chemicals Agency (ECHA) 'Guidance on requirements for substances in articles' posted at this URL: <https://echa.europa.eu/guidance-documents/guidance-on-reach>

Compatible Parts



TE Part # 60619-5
CMNL SOK AUBR L/P

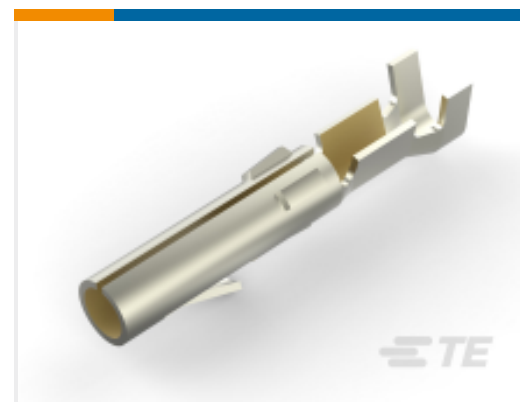

TE Part # 60617-5
CMNL SOK AUBR L/P

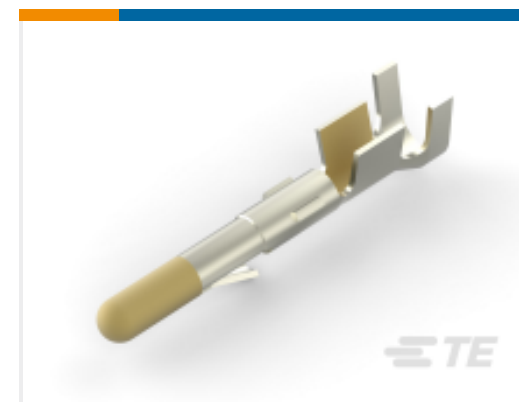

TE Part # 60618-5
CMNL PIN AUBR L/P



TE Part # 60617-4
CMNL SOK PTPPHBZ L/P



TE Part # 61173-1
CMNL SOK 30-22 PTBR L/P



TE Part # 60619-1
CMNL SOK PTPBR L/P



TE Part # 60620-1
CMNL PIN 20-14 TPBR L/P



TE Part # 60617-1
CMNL SOK SNBR L/P



Also in the Series | Commercial MATE-N-LOK

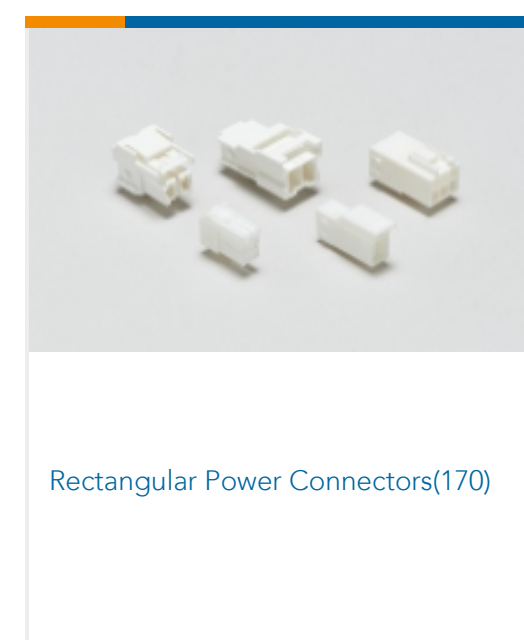
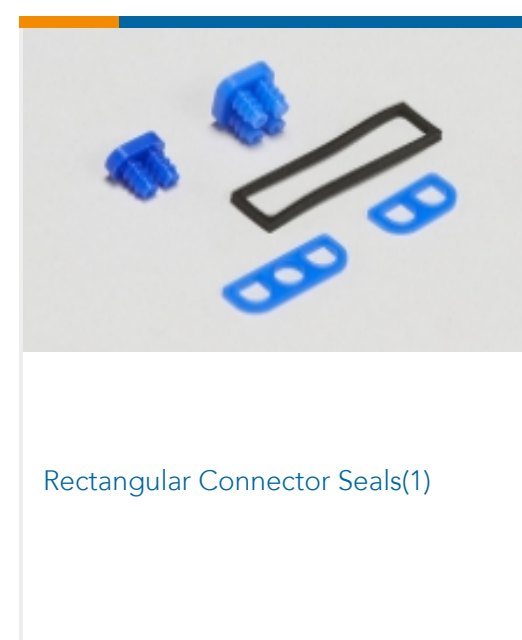
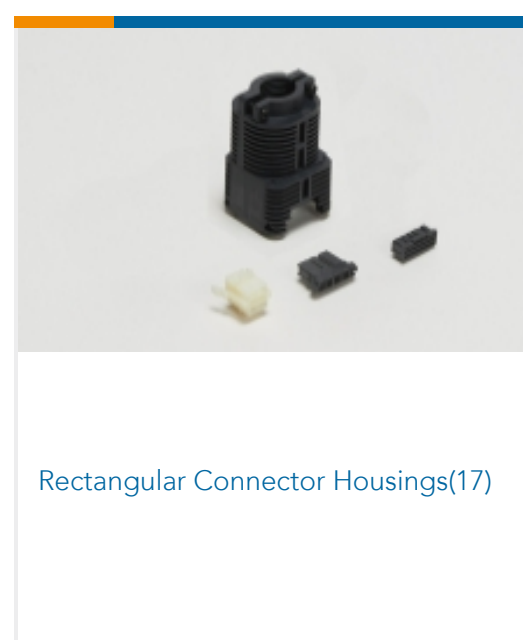
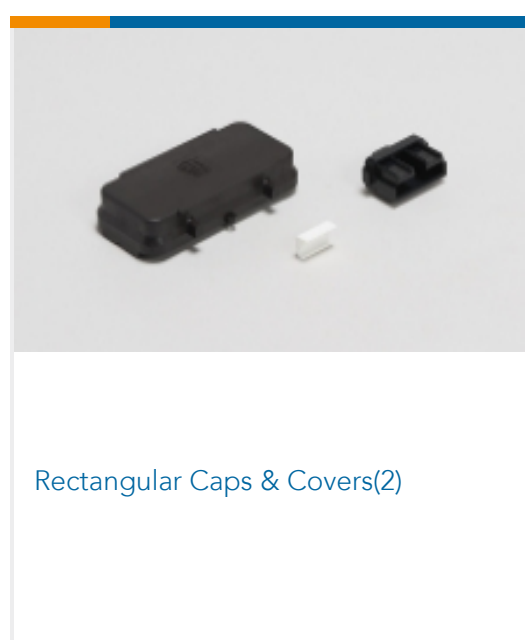
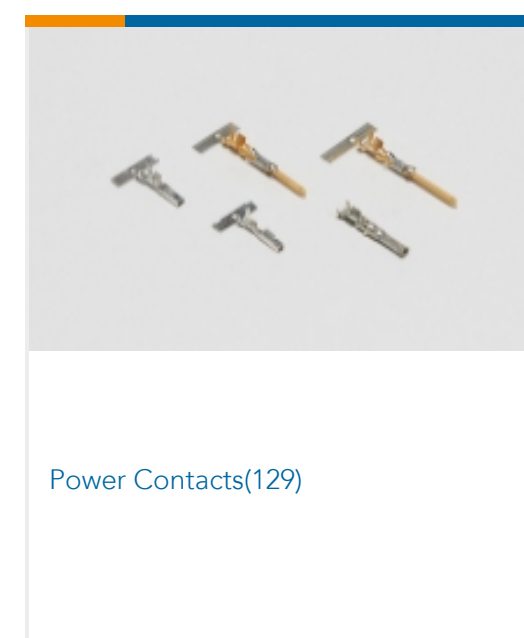
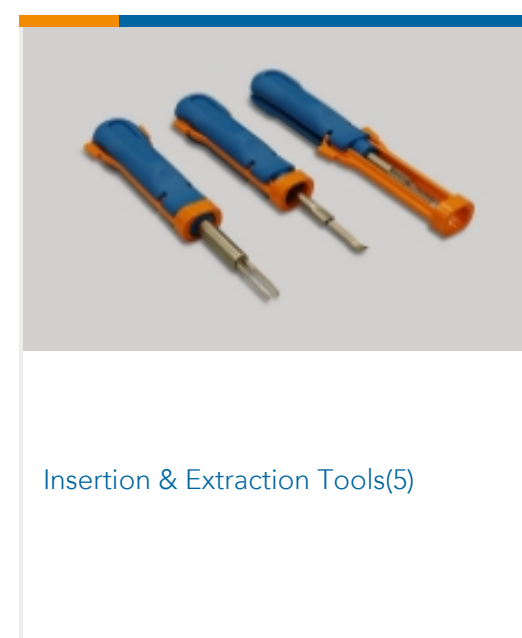
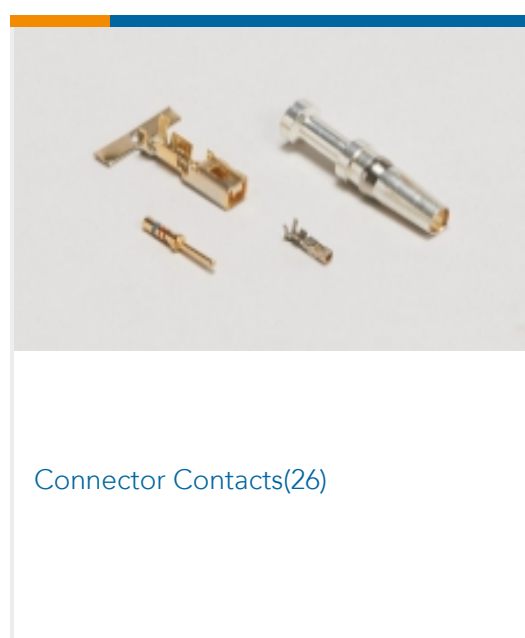



Standard Circular Connectors(4)

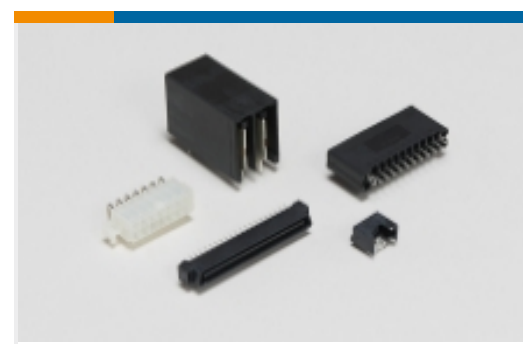

Standard Rectangular Connectors(10)



Wire-to-Board Connector Contacts(1)

Documents

Product Drawings

[01P CMNL PLUG HSG F/H NATL](#)

English

CAD Files

[3D PDF](#)

English

Customer View Model

[ENG_CVM_1-480349-0_K.2d_dxf.zip](#)

English

Customer View Model

[ENG_CVM_1-480349-0_K.3d_igs.zip](#)

English

Customer View Model

[ENG_CVM_1-480349-0_K.3d_stp.zip](#)

English

[3D PDF](#)

3D

Customer View Model

[ENG_CVM_CVM_1-480349-0_AK.2d_dxf.zip](#)

English

Customer View Model

[ENG_CVM_CVM_1-480349-0_AK.3d_igs.zip](#)

English

Customer View Model

[ENG_CVM_CVM_1-480349-0_AK.3d_stp.zip](#)

English

By downloading the CAD file I accept and agree to the [Terms and Conditions](#) of use.

Datasheets & Catalog Pages

[SOFT_SHELL_PIN_SOCKET_CONNECTORS_STANDARD_DENSITY](#)

English

Product Specifications

[Application Specification](#)



English

Product Environmental Compliance

[MD_1-480349-0_060620181331_dmtec](#)

English

[MD_1-480349-0_060620181331_dmtec](#)

English

Instruction Sheets

[Instruction Sheet \(U.S.\)](#)

English

[Instruction Sheet \(U.S.\)](#)

English

Agency Approvals

[Agency Approval Document](#)

English